

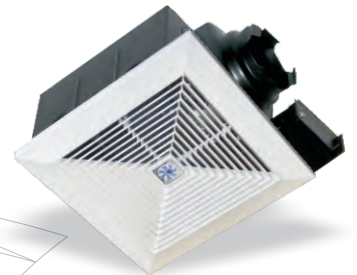

by Air Specialties

# INSTALLATION INSTRUCTIONS



**SA-50E**  
**SA-70E**  
**SA-90E**



**SA-90EL**



**SA-150E**  
**SA-200E**



**SA-90ELM**



**SA-90EM**

**AIR SPECIALTIES LTD.**

Toll Free: 1.866.890.6457  
1.800.810.3473

# READ AND SAVE THESE INSTRUCTIONS

## GENERAL SAFETY INFORMATION

1. Do not install this fan where air temperature may exceed 40°C (104°F).
2. The electric service supply voltage must be 120V/60HZ.
3. Do not kink or excessively bend the electrical wires.
4. Follow all the appropriate codes, i.e. local electrical and safety codes, the National Electrical Codes (NEC) and the Occupation Safety And Health Act (OSHA) .
5. Always disconnect the electrical wires before working on or near the fan, motor, or junction box
6. Protect the electrical wires from sharp edges, oil, grease, hot surfaces, chemicals, or other objects.
7. Do not install the unit where ducts where the airflow can be severely restricted.
8. There should always be an adequate air supply to the vented area.
9. This unit is acceptable for use over a bathtub or shower when installed with GFCI protected branch circuit. The control device should not be installed within reach of the bathtub or shower.

## CAUTION

- Do not use in cooking area or kitchens
- This unit must be grounded
- Do not use to exhaust hazardous or explosive materials and vapor  
(For General Ventilation Only)

## WARNING

1. Use this unit only in the manner intended by the manufacturer. If you have any questions, contact the manufacturer.
2. Installation work and electrical wiring must be done by qualified person(s) in accordance with all applicable codes and standards, including fire-rated construction.
3. When cutting or drilling into a wall or ceiling, do not damage electrical wiring and other hidden utilities.
4. Before servicing or cleaning unit, switch power off at service panel and lock the service disconnecting means to prevent power from being switched on accidentally. When the service disconnecting means can't be locked, securely fasten a prominent warning device, such as a tag, to the service panel.

## UNPACKING

Unpack the fan very carefully from the box. Check all components listed in the accessories are included. If any components are missing, please contact factory or authorized distributor.

## ACCESSORIES

a) **1 pc.** Grille



SA-50E, SA-70E  
SA-90E models

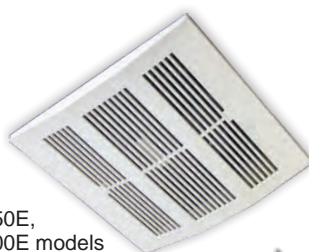

SA-150E,  
SA-200E models

b) **2 pcs.** Mounting Bracket



c) **2 pcs.** Bracket  
Extension



d) **4 pcs.** Bracket  
Extension  
Screws (3/8")



e) **8 pcs.** Sheet Metal  
Screws (1 1/4" long)



# MODEL SA-90SL / SLM ACCESSORIES

## a) 1 pc. Light Grille

Fan/Light Grille

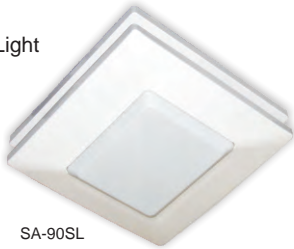

SA-90SL

Fan/Light Motion Sensor Grille



SA-90SLM

## b) 1 pc. Light Unit



## c) 2 pcs. Fluorescent Bulb, 2 pins, 13W



(Model: 13WPL)

### WARNING:

Bulb contains Mercury, dispose it according to local, state & federal laws and regulations.

# MODEL SA-90SM

## a) 1 pc. Grille with Motion Sensor

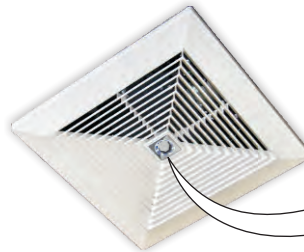

Motion Sensor

### These Ceiling Mount Ventilating Fan Models Utilizes:

- A PSC motor, designed to have an extended service life and reduced energy consumption with thermal cut-off for safety and over load protection
- Plastic grille - quick dismount type
- Plastic Blower wheel for super quiet performance
- Back draft O/L damper

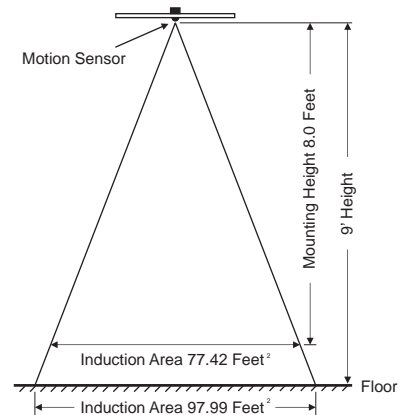

## WIRING DIAGRAM

### A) SA-50E, SA-70E, SA-90E SA-150E, SA-200E

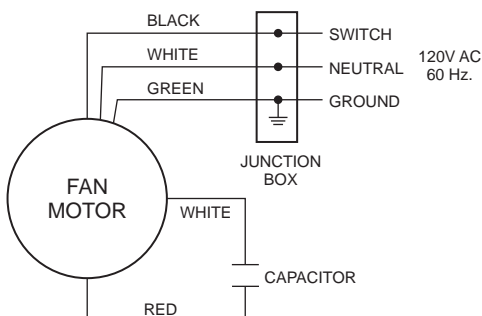

### B) SA-90EM

(Fan with motion sensor)

**NOTE:**  
CONNECT / DISCONNECT CAREFULLY WHILE REMOVING / REPLACING THE FAN GRILLE

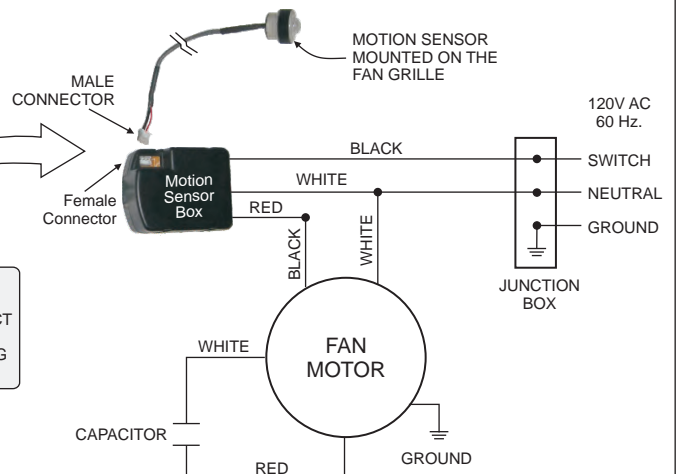

## **WIRING DIAGRAM:** (cont.)

### **C) SA-90EL**

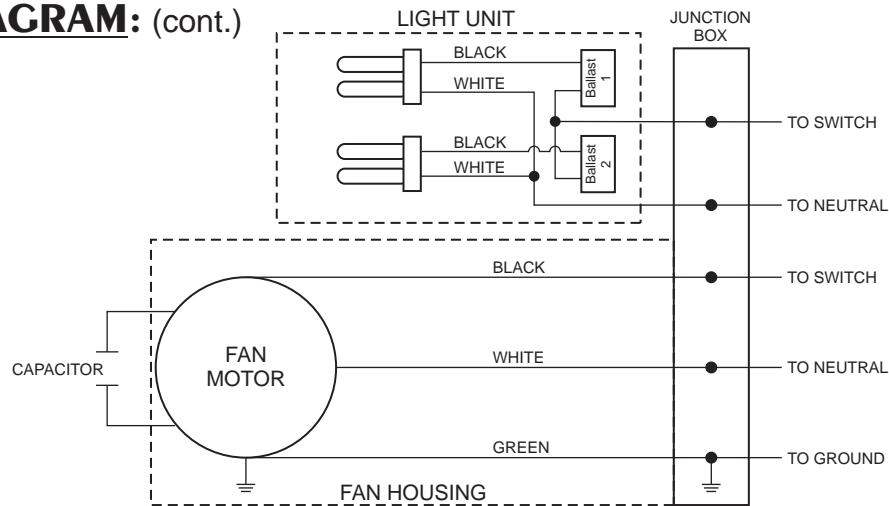

## **INSTALLATION**

### **A) Wooden Joist Installation**

- Install fan housing between ceiling joists using sufficient length of screws as shown in Fig. 1 with the fan O/L facing the desired exhaust duct direction.
- Install fan mounting brackets as shown in Fig. 2 to the fan sides that are not connected to the joists.
- If the brackets are too short to reach the joist, use bracket extensions
- Connect the circular duct to the backdraft damper. Secure with duct tape and make sure there is no air leakage.
- Do not use power supply wires smaller than 14 AWG.
- Always use the metal duct and try to avoid flexible duct



### **B) Existing Construction**

Before cutting a new hole in the existing ceiling:

- Choose best location (next to ceiling joist)
- Make sure the duct work can be installed and has easy access to exterior air outlet
- Wiring can be run to the planned area
- Make sure no existing wiring or other obstruction will interfere with installation
- Follow Installation A

### **NOTE:**

In case of replacing an old unit, check existing duct work and electrical wiring and follow installation A.

## **CLEANING**

- Disconnect power supply
- Remove fan grille
- Clean grille with warm water and mild detergent (liquid soap). Do not use harsh detergent or boiling water
- Dry grille with a cloth or towel
- Clean fan blades carefully
- Never allow water to enter into the motor
- Replace fan grille in place